

1. LEXICON

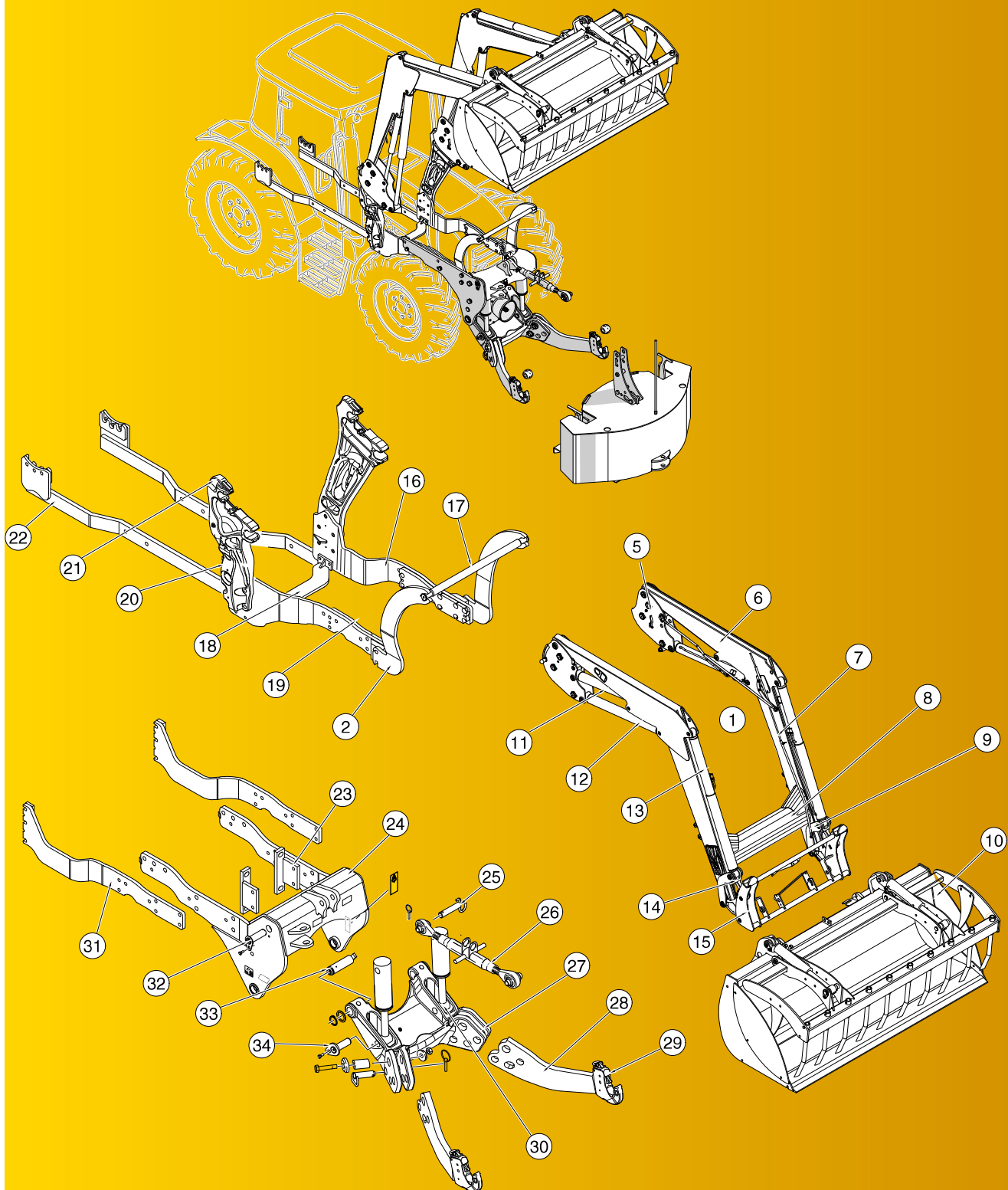





- | | | | |
|-------------------------------|--|-------------------------|---|
| 1 Frontlader | 11 PCH-cilinder (hydraulische parallelgeleiding) | 20 Aanbouwdeelstang | 30 Cilinderpin |
| 2 Beschermbeugel tractorfront | 12 Hefcilinder | 21 Aanbouwframe | 31 Fronthefchassis |
| 3 Contragewicht | 13 Kipcilinder | 22 Versteving achteraan | 32 Pen cilinderopening |
| 4 Fronthef | 14 Vulstang | 23 Driehoek voorzijde | 33 Scharnierpen hefinrichting-aanbouw delen |
| 5 Frontladerframes | 15 Werktuigdrager | 24 Aanbouwdeel fronthef | 34 Pen cilinderstang |
| 6 Naakte laadarm | 16 Aanbouw delen | 25 3-puntspen | |
| 7 Vrije stang | 17 Beschermingsstang | 26 3-puntsstang | |
| 8 Dwarsbalk frontlader | 18 Centrale dwarsbalk | 27 Hefinrichting | |
| 9 Kantelarm | 19 Frame aanbouwdeel | 28 Arm | |
| 10 Werktuigen | | 29 Haak | |

2. MECHANISCH

Slijtbussen

Referentie	Naam $\varnothing A \times \varnothing B / h$	Afbeelding
		
304731	Slijtbus 25 x 28 / 20	
304732	Slijtbus bimetaal 30 x 34 / 20	
304721	Slijtbus staal 30 x 38 / 22	
304733	Slijtbus bimetaal 35 x 39 / 20	
304734	Slijtbus bimetaal (MX150/ U6, U8, U10, U12/U300) 35 x 39 / 30	
304725	Slijtbus bimetaal 40 x 44 / 20	
304722	Slijtbus bimetaal 40 x 44 / 30	
524788	Slijtbus 40 x 44 / 60 Arcor (Serie T400)	

Set pennen + bussen: Compleet

Referentie	Benaming	Modellen	Afbeelding
328602	MX 40.55 40.70 40.85 6000		
328600	MX 60 80 100 120		
519025	MX 60.5 80.5 100.5 120.5		
328601	MX 150 en MX 155 MX 150.5 en MX 155.5		
506714	MX Technic serie T voor I/2010	MX T8 tot T15	
523007	MX Technic serie TS voor I/2010	MX T8S tot T15S	
519026	MX Technic serie T vanaf I/2010	MX T8 tot T15	 
518624	MX Utility 09 voor 2010	MX U8 / U10 / U12	
522928	MX Utility 09 voor 2010	MX U6	
522929	MX Utility U09 na 2010 en serie U300	MX U6 MX U303 tot U306	
	MX serie U400	MX U403 tot U406	

Referentie	Benaming	Modellen	Afbeelding
519690	MX Utility U09 en serie U300 MX serie U400	MX U8 tot U12 MX U307 tot U312 MX U407 tot U412	
527875	MX serie T400	MX T408 tot T412	
527876	MX serie T400	MX T414 tot T418	
548555	MX serie A100	MX A104 / A106 / A110	

Set pennen + bussen: Kiepen

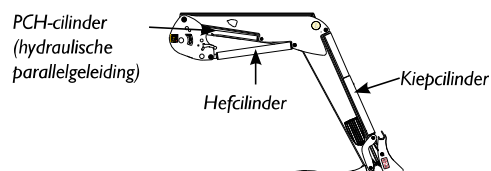

Referentie	Benaming	Modellen	Afbeelding
506715	MX Technic serie T voor 1/2010	MX T8 tot T15	
519028	MX Technic serie T vanaf 1/2010	MX T8 tot T15	
518625	MX Utility 09 voor 2010	MX U8 / U10 / U12	
522930	MX Utility 09 voor 2010	MX U6	
522932	MX Utility U09 na 2010 en serie U300 MX serie U400	MX U6 / U303 tot U306 MX U403 tot U406	
527877	MX serie T400	MX T408 tot T412	
527878	MX serie T400	MX T414 tot T418	
519694	MX Utility U09 versie 2010 en serie U300 MX serie U400	MX U8 tot U12 MX U307 tot U312 MX U407 tot U412	
548559	MX serie A100	MX A104 / A106 / A110	

Reparatieset voor aanzetstuk onderste arm (D + G)

Referentie	Benaming	Afbeelding
308844	MX 60 tot MX 120	
308844	MX 60.5 tot MX 120.5	
336995	MX 150 en MX 155 MX 150.5 en MX 155.5	
	MX Technic serie T06 / T400 MX Utility serie U09 / U300 / U400	
520366		

x2

Reparatieset voor aanzetstuk bovenste arm (D + G)

Referentie	Benaming	Afbeelding
326087	MX 60 tot MX 120	
326087	MX 60.5 tot MX 120.5	
326088	MX 150 en MX 155 MX 150.5 en MX 155.5	

x2

Referentie	Benaming	Afbeelding
521532	MX Technic serie T06 / T400 MX Utility serie U09 / U300 / U400	

Frontladerpennen (lengte onder kop)

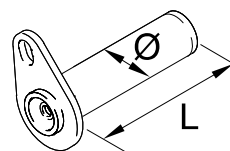

Referentie	Naam $\varnothing \times L$	Afbeelding
309650	Pen 25 x 82	
309651	Pen 25 x 113 (vervangt 089118 pen 25 x 104 MX 255)	
311751	Pen 25 x 175	
307316	Pen 30 x 85 + Smeernippel	
517647	Pen 30 x 89 + Smeernippel (PCH-cilinder kant van de opening na 01-2010)	
312835	Pen 30 x 90 voor hydraulisch stuk MX 260	
307317	Pen 30 x 108 + Smeernippel (pen op werktuigdrager Master-Attach 97)	
307322	Pen 30 x 108 + Smeernippel met 3 gaten	
520826	Pen 30 x 117 + Smeernippel	
312065	Pen 30 x 118 Zonder smeernippel	
307318	Pen 30 x 118 + Smeernippel	
307323	Pen 30 x 124 + Smeernippel + 1 gat \varnothing 8 mm	
307319	Pen 30 x 135 + Smeernippel (vervangt 089151 / FB8915100)	
307324	Pen 30 x 150 + Smeernippel + Geboord (vervangt 089181)	
311224	Pen 30 x 155 + Smeernippel + Geboord	
313717	Pen 30 x 182 + Smeernippel + Geboord (vervangt 311754)	
311964	Pen 35 x 85 + Smeernippel	
517661	Pen 35 x 90 + Smeernippel	
517666	Pen 35 x 99 + Smeernippel (onderste pen werktuigdrager frontladers T-Evolution)	
307320	Pen 35 x 100 + Smeernippel (onderste pen werktuigdrager MX 80 / 100 / 120)	
333394	Pen 35 x 110 + Smeernippel (frames Fitlock II MX.5)	
504856	Pen 35 x 116 + Smeernippel	
311186	Pen 35 x 120 + Smeernippel	
517670	Pen 35 x 122 + Smeernippel + groef (T-serie)	
307321	Pen 35 x 130 + Smeernippel (1/2 frame Fitlock MX 80 / 100 / 120)	
504860	Pen 40 x 134 + Smeernippel (1/2 frame Fitlock I T06)	
526628	Pen 40 x 134 (werktuigdrager Master-Attach/Faucheux blanc)	
311223	Pen 40 x 130 / 170 + Smeernippel (gegroefd) /	
304581	31122, Moer HM24 P:3 8 MX150 / T15	
311327	Pen 40 x 175 + Smeernippel	

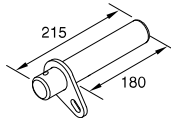
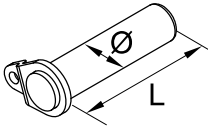

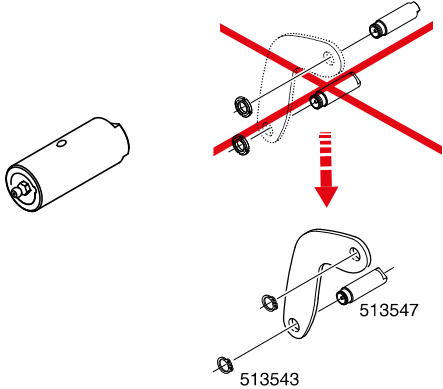
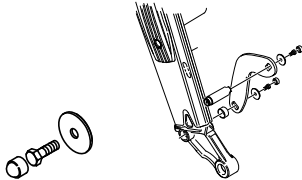

Referentie	Naam Ø x L	Afbeelding
328469	Pen 30 x 215	
517651	Pen 30 x 115 + Smeernippel + Geboord	
503042	Pen 30 x 112 + Smeernippel + Geboord	
517677	Pen 35 x 136 + Smeernippel	
517683	Pen 40 x 141 + Smeernippel (bovenste pen Fitlock II-frame na 01-2010)	
517690	Pen 40 x 112 + Smeernippel (onderste pen werktuigkader na 01-2010)	

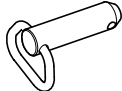
Referentie	Naam Ø x L	Afbeelding
503161	Pen 30 x 80,5 (pen PCH-cilinder kant met opening voor 01/2010)	
503036	Pen 35 x 80,5	
503038	Pen 35 x 96,5 (bovenste pen werktuigdrager)	
513547	Pen 35 x 118 + groef (kippen)	
506874	Pen 35 x 119	
503048	Pen 35 x 129,5 (onderste pen Fitlock II-frame hefcilinderstang)	
503050	Pen 40 x 106,5 (onderste pen werktuigdrager)	
503052	Pen 40 x 129,5 (bovenste pen Fitlock II-frame voor 2010)	
513543	Borgringen dikte 2 mm versterkt (voor gegroefde as)	
503597	Afdekkap	
505885	Bout met loctite	
503333	Ring	

Fronthefpennen

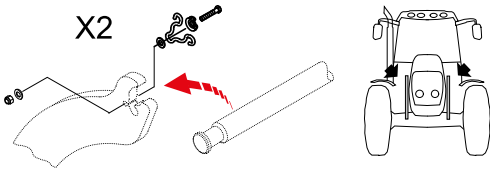

Referentie	Naam Ø x L	Afbeelding
331101	Vergrendelpen Ø30 x 82 / 110	
306525	Vergrendelpen Ø 30 x 100 / 128 MX P19 / R28 / R38 / R53	
517751	Vergrendelpen Ø35 x 129.5 (gevormde hefinrichting)	
331536	Pen 35 x 183 + Smeernippel	
312586	Pen 40 x 120 (pen voor hefinrichting)	
331483	Pen 30 x 180 + Smeernippel	

Diverse kits

Referentie	Benaming	Afbeelding
329142	Reparatieset aanbouwdeel AD90 *	
504638	Montagekit beschermingsstang	
516085	Handvatkit voor Fitlock II-frames (voor AD05**)	

* AD90 (van 1990 tot 2005)
** AD05 (vanaf 2005)

Afdekkappen steunpoten (rechts en links)

Referentie	Benaming	Afbeelding
MX T6: 523430 MX T8..T16: 519245 MX U6..U12: 523424 MX U300 - T400: 523424	TECHNIC-SERIE T06 vanaf 1/2010 SERIE U09 U300 en serie T400	
503483	TECHNIC-SERIE T06 vanaf 1/2010	
311282	TECHNIC-SERIE MX60 - 155	

3. HYDRAULISCH

Koppelingen voor cilinders, serie U09, serie U300, serie U400 & serie A100



Referentie	Benaming	Type frontlader
503382	Afdichtset voor hefcilinder	U303, U304, U403, U404
518162	Afdichtset voor hefcilinder	U6, U6//, U305, U306, U405, U406
328593	Afdichtset voor hefcilinder	U8, U10, U10//, U12//, U307, U309, U310, U312, U407, U409, U410, U412
503382	Afdichtset voor hefcilinder	U8//, U308, U408
503385	Afdichtset voor hefcilinder	U414
548624	Afdichtset voor hefcilinder	A104
548625	Afdichtset voor hefcilinder	A106
548626	Afdichtset voor hefcilinder	A110
518152	Afdichtset voor kipcilinder	U6, U6//, U303, U304, U403, U404, U405, U406
518135	Afdichtset voor kipcilinder	U8, U8//, U10, U10//, U12// U307, U308, U309, U310, U312, U407, U408, U409, U410, U412
547981	Afdichtset voor kipcilinder	U414
535668	Afdichtset voor kipcilinder	A104
548628	Afdichtset voor kipcilinder	A106
548629	Afdichtset voor kipcilinder	A110

// = frontlader met mechanisch parallellogram

Koppelingen voor cilinders, serie T06 en serie T400



Referentie	Benaming	Type frontlader
518162*	Afdichtset voor hefcilinder	T6, T406,
503382	Afdichtset voor hefcilinder	T8, T408,
328593	Afdichtset voor hefcilinder	T10, T410,
503385	Afdichtset voor hefcilinder	T12, T412, T414
503389	Afdichtset voor hefcilinder	T15 / T16, T417 / T418
503445	Afdichtset voor kipcilinder	T6, T406
503424	Afdichtset voor kipcilinder	T8, T10 T408, T410,
503434	Afdichtset voor kipcilinder	T12, T15 / T16 T412, T414
528940	Afdichtset voor kipcilinder	T417 / T418
328588	Afdichtset voor PCH-cilinder	T6, T406,
503407	Afdichtset voor PCH-cilinder	T8, T10, T408, T410
328596	Afdichtset voor PCH-cilinder	T12, T15 / T16 T412, T414
528942	Afdichtset voor PCH-cilinder	T417 / T418

* bij cilinderopening met binnendiameter van 55 mm: 503393



Koppelingen voor cilinders, TECHNIC-series

Referentie	Benaming	Type frontlader
328587	Afdichtset voor hefcilinder	MX 40 / MX 40.5, MX FR
328584	Afdichtset voor hefcilinder	MX 60, MX 60.5
328592	Afdichtset voor hefcilinder	MX 80, MX 80.5
328593	Afdichtset voor hefcilinder	MX 100, MX 100.5
328590	Afdichtset voor hefcilinder	MX 120, MX 120.5
328595*	Afdichtset voor hefcilinder	MX 150 / MX 150.5, MX 155 / MX 155.5
328589	Afdichtset voor kipcilinder	MX 40 / MX 40.5, MX FR, MX 60, MX 60.5
328591	Afdichtset voor kipcilinder	MX 80, MX 80.5, MX 100, MX 100.5
328597	Afdichtset voor kipcilinder	MX 120, MX 120.5, MX 150 / MX 150.5, MX 155 / MX 155.5
328588	Afdichtset voor PCH-cilinder	MX 40 / MX 40.5, MX FR, MX 60, MX 60.5
328594	Afdichtset voor PCH-cilinder	MX 80, MX 80.5, MX 100, MX 100.5
328596	Afdichtset voor PCH-cilinder	MX 120, MX 120.5, MX 150 / MX 150.5, MX 155 / MX 155.5

* Bij een binnenste diameter van de cilinder van 80 mm: 305349 + 305348

Koppelingen voor cilinders, series ROOD

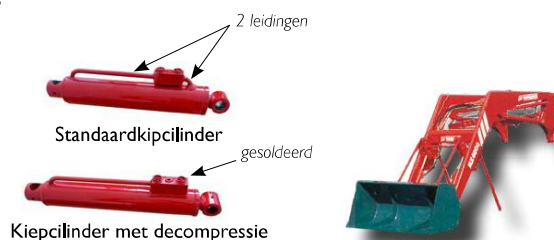

Referentie	Benaming	Type frontlader
305261	Afdichtset voor enkelwerkende hefcilinder	MX 40.55
305263	Afdichtset voor enkelwerkende hefcilinder	MX 40.70
305266	Afdichtset voor enkelwerkende hefcilinder	MX 40.85
305267	Afdichtset voor enkelwerkende hefcilinder	MX 6000
305321	Afdichtset voor dubbelwerkende hefcilinder	MX 40.FR
305315	Afdichtset voor dubbelwerkende hefcilinder	MX 40.55
305324	Afdichtset voor dubbelwerkende hefcilinder	MX 40.70
305341	Afdichtset voor dubbelwerkende hefcilinder	MX 40.85
305347	Afdichtset voor dubbelwerkende hefcilinder	MX 6000
305306	Afdichtset voor standaardkipcilinder	MX 40.FR, MX 40.55, MX 40.70
305310	Afdichtset voor standaardkipcilinder	MX 40.85, MX 6000
305275	Afdichtset voor PCH-cilinder	MX 40.FR, MX 40.55, MX 40.70
305279	Afdichtset voor PCH-cilinder	MX 40.85, MX 6000

Referentie	Benaming	Type frontlader
305309	Afdichtset voor kpicilinder links (met decompressie)*	MX 40.FR, MX 40.55, MX 40.70
305313	Afdichtset voor kpicilinder links (met decompressie)*	MX 40.85, MX 6000

* Alleen voor hefcilinder met enkelvoudige werking + PCH.

Flexibele leidingen

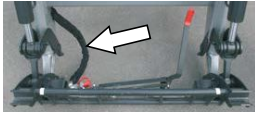
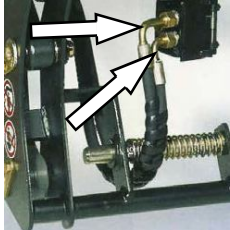



Referentie	Benaming	Afbeelding
516968	Beschermend omhulsel voor leidingen Alle modellen laders Omhulsel van zwart polyester L: 850 mm	
305633	Leidingen voor 3e functie Laders MX 60 - 80 - 100 - 120 - 150 - 155 Leiding 1/2 - MI5 (90°) - ET15 (90° - 70) L: 750 mm	
305632	Leidingen voor 3e functie Laders MX 60 - 80 - 100 - 120 - 150 - 155 Leiding 1/2 - MI5 (90°) - ET15 (90° - 46) L: 750 mm	



Relaisblok

Referentie	Benaming	Afbeelding
305697	Koppeling ISO (mannelijk)	
305696	Koppeling ISO (vrouwelijk)	
506176 Set met 10 blauwe koppelingen, Ø 20,29 mm x 2,62 mm	O-ring blauw vrouwelijke koppeling ISO (90 shore)	

Compacte Frontlader - Groene zones

Referentie	Benaming	Afbeelding
305680	Koppeling (mannelijk) (3/8) met MX-verdeler	
305678	Koppeling (mannelijk) (3/8) met originele verdeler	
305679	Koppeling (vrouwelijk) (3/8)	
320171	Koppeling (vrouwelijk) (90 shore)	

Lader / Werktuig Alle frontladers (ISO)

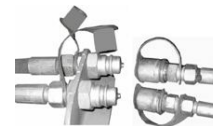

Referentie	Benaming	Afbeelding
305684***	Mannelijke koppeling ISO (X = 25 mm, Ø 18 mm)	
305697***	Mannelijke koppeling ISO (X = 27 mm, Ø 22 mm)	
305690	Koppeling ISO (vrouwelijk)	
506176 Set met 10 blauwe koppelingen, Ø 20,29 mm x 2,62 mm	O-ring blauw vrouwelijke koppeling ISO (90 shore)	
305408 x 1 rode koppeling (voorheen groen)	O-ring rood vrouwelijke koppeling NS (90 shore)	

*** Serie Technic = Ref: 305697 - rode serie = Ref: 305684.

SPEED-LINK

Referentie	Benaming	Afbeelding
305708	Mannelijke NS-koppeling (vlakke kant)	
305709	Vrouwelijke NS-koppeling (vlakke kant)	
305408 x 1 rode koppeling (voorheen groen)	O-ring rood vrouwelijke koppeling NS (90 shore)	
525215	Verbeteringskit SPEED-LINK-stekker met veren	

Accumulatoren



Referentie	Benaming	Afbeelding
305842	Accumulator 0,6 L Ø 122 mm (vervangt accumulator 0,75 L, Ref. 305843)	
538356	Accumulator 0,6 L Ø 108 mm	
501312	Lagedrukaccumulator (0,16 L)	

4. MACH SYSTEM

Hydraulische koppelingen

(oude serie / nieuwe serie)

ISO: center en NS: vlakke kant

MACH 90 (rood handvat)

MX 40.55 tot 6000 Serienummer < 10000



L: 150 mm / l: 100 mm / H: 140 mm

Referentie	Benaming	Afbeelding
300516	Afdekkap	
305686	Koppeling ISO (mannelijk) (X = 14 mm)	
305687	Koppeling ISO (vrouwelijk)	
506176 Set met 10 blauwe koppelingen, Ø 20,29 mm x 2,62 mm	O-ring blauw vrouwelijke koppeling ISO (90 shore)	

312007 Vernieuwingskit voor vergrendeling

MACH 92 (grijze hendel)

MX 40.55 tot 6000m Serienummer > 10000

341810 : Sokkel

341812 : Klok



L: 165 mm / l: 120 mm / H: 110 mm









Referentie	Benaming	Afbeelding
300518	Afdekkappen	
305688 x 4	Koppeling ISO (mannelijk) 22 x 150 (X = 44 mm)	
305692 x 1	Koppeling ISO (mannelijk) 18 x 150 (X = 44 mm)	
305690 x 4	Koppeling ISO (vrouwelijk) 22 x 150	
305694 x 1	Koppeling ISO (vrouwelijk) 18 x 150	
506176 Set met 10 blauwe koppelingen, Ø 20,29 mm x 2,62 mm	O-ring blauw vrouwelijke koppeling ISO (90 shore)	
312020	Vernieuwingskit voor vergrendeling	

MACH 2000

MX FR tot MX 155 - Serie T06, U09 - Serie T400, serie U300











Referentie	Benaming	Afbeelding
528388	Huis MACH op frontlader (NS) (lekdicthe NS-koppelingen)	
528631	Sokkel MACH voor sturing (NS) (lekdicthe NS-koppelingen) originele tractor	
300520	Afdekkap MACH 2000	
313693	Geheel afdekkap MACH 2000 (veer + pen)	
313953	Geheel mantel MACH 2000	
305697*	Koppeling ISO (mannelijk) (X = 27 mm)	
305688	Koppeling ISO (mannelijk) (X = 44 mm)	
305686**	Koppeling ISO (mannelijk) (X = 14 mm)	
305698	Koppeling ISO (vrouwelijk)	
524782	Mannelijke NS-koppeling (vlakke kant)	
527432	Kit 5 koppelingen (5 x 524782) (X = 44 mm)	
524765	Vrouwelijke NS-koppeling (vlakke kant)	
527430	Kit 5 koppelingen (5 x 524765)	
305708	Mannelijke NS-koppeling (vlakke kant)	
527431	Kit 5 koppelingen (5 x 305708) (X = 27 mm)	
506176	O-ring blauw vrouwelijke koppeling ISO (90 shore)	
Set met 10 blauwe koppelingen, Ø 20,29 mm x 2,62 mm		
305408	O-ring rood vrouwelijke koppeling NS (90 shore)	
x 1 rode koppeling (voorheen groen)		

313695	Koppelstuk Ø 10 mm		
506477	Koppelstuk Ø 16 mm		
522475	Tussenzetstuk Pro/Flex/Tech		
305352	Afdichting voor Pro/Flex/Tech		
319943	Kit reservoir vervangt oud reservoir dat niet langer leverbaar is * Alle series gemengd		

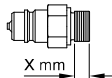

* Als de 5 mannelijke koppelingen dezelfde lengte hebben, 5 x bestellen Ref: 305697.

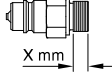
** Als de 4 koppelingen dezelfde lengte hebben en de 5e korter is, 4 x bestellen Ref: 305688 + 1 Ref: 305686.

MACH 2

Referentie	Benaming	Afbeelding
336039	Mannelijke MACH 2-stekker (NS) (lekdicte NS-koppelingen)	
527895	Vrouwelijk MACH 2-blok (NS) (lekdicte NS-koppelingen)	
300519	Afdekkap	
549518	Schuif MACH 2	
540648	Koppeling ISO (mannelijk) (X = 27 mm)	 
305698	Koppeling ISO (vrouwelijk)	
540278	Mannelijke NS-koppeling (vlakke kant) (X = 27 mm)	 
524765	Vrouwelijke NS-koppeling (vlakke kant)	
305979	Klinkmoer	
506176 Set met 10 blauwe koppelingen, Ø 20,29 mm x 2,62 mm	O-ring blauw vrouwelijke koppeling ISO (90 shore)	
305408 x 1 rode koppeling (voorheen groen)	O-ring rood vrouwelijke koppeling NS (90 shore)	

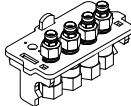
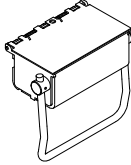
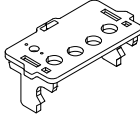
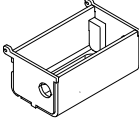
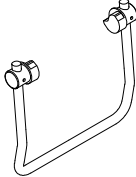
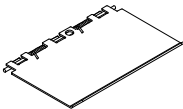
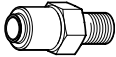
MACH COMPACT

Referentie	Benaming	Afbeelding
540989	Huis MACH compact volledig (met 3e functie)	
540988	Sokkel MACH compact volledig (met 3e functie)	
539215	Huis Mach compact naakt	
539156	Sokkel MACH compact naakt	
539193	Geheel nok MACH compact	
539191	Afdekkap	
539189	Koppeling NS (mannelijk)	
524765	Koppeling NS (vrouwelijk)	
334226	Steun MACH	

5. BESTURING

MX 460 - 480 - 600, MX 260 - 280
 MX 20.55 - 20.70, MX 40.55 - 40.70 - 40.85, MX 6000
 MX 40FR

Van 1987 tot 1994



Bedieningshendels (aluminium voetstuk)

Referentie	Benaming	Afbeelding
300622	Bedieningshendel met 2 functies	
300624	Bedieningshendel met 3 functies 1 knop	
306243	Schakelaar met plaat voor Cobra-bedieningshendel	
300612	Totale lengte: 1.000 mm	
300609	Totale lengte: 1.200 mm	
300608	Totale lengte: 1.400 mm	
300610	Totale lengte: 1.700 mm	
300611	Totale lengte: 2000 mm	
300613	Totale lengte: 2300 mm	
300626	Vast scharnier	
300635	Balg	
300627	Lange scharnier van eenhendelbediening	
300620	Mechanische ontgrendelingskabel lengte: 3.000 mm (voor bak) MX 260 – MX 280, MX 20.55 – MX 20.70	







MX 460 - 480 - 600, MX 260 - 280
 MX 20.55 - 20.70, MX 40.55 - 40.70 - 40.85, MX 6000
 MX 40FR



Van 1994 tot 1997

Bedieningshendels (plastic voetstuk)

Referentie	Benaming	Afbeelding
Geen referentie beschikbaar Vervangen door 326084	Bedieningshendel met 3 functies 1 knop	
Geen referentie beschikbaar Vervangen door 326084	Bedieningshendel 4 functies 2 knoppen	
326084	Bedieningshendel 4 functies 2 knoppen (geen gedetailleerde elektronische kaart)	
326085	Bedieningshendel 6 functies 4 knoppen (geen gedetailleerde elektronische kaart)	
316204	Hendel met 2 knoppen (geen gedetailleerde elektronische kaart)	
316203	Hendel met 4 knoppen (geen gedetailleerde elektronische kaart)	





Referentie	Benaming	Afbeelding
306256	Dop (Hendel eerste generatie)	
306244	Schakelaar (Hendel eerste generatie)	
300652	Aluminium as	
300655	Vast scharnier	
300648	Bedieningsconsole (bevat aluminium as en vast scharnier)	
300651	Balg	

Kabels

Referentie	Benaming	Afbeelding
319736	Totale lengte: 1.100 mm	 moer
300680	Totale lengte: 1300 mm	
300679	Totale lengte: 1500 mm	
300668	Totale lengte: 1800 mm	
300669	Totale lengte: 2100 mm	
300675	Totale lengte: 2400 mm	
300676	Totale lengte: 2800 mm	
300677	Totale lengte: 3000 mm	
300670	Totale lengte: 3200 mm	
300678	Totale lengte: 3400 mm	
300671	Totale lengte: 3600 mm	
300672	Totale lengte: 3800 mm	
300673	Totale lengte: 4000 mm	
300674	Totale lengte: 4200 mm	

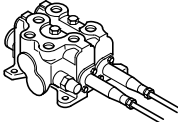

Verbinding verdeler









Referentie	Benaming	Afbeelding
	 SM12 / SPI2. Verdeler onder de cabine van de tractor	
300619	Kit voor kabelkoppeling / schuif voor bedieningshendel met aluminium voetstuk (2-deelsbehuizing – L: 95 mm)	
305811	Afdichtset SM12 (open centrum)	
300681	Kit voor kabelkoppeling / schuif voor bedieningshendel met plastic voetstuk (6-deelsbehuizing – L: 90 mm)	
305810	Set met interne SPI2-koppelingen (Load Sensing)	





MX 60 - 80 - 100 - 120 - 150
 MX T6 - T8 - T10 - T12 - T15 - T16
 MX U6 - U8 - U10 - U12

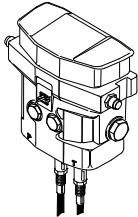

Van 1997 tot 3/2013

PROPILOT - Hydraulisch en Enkelwerkend / Dubbelwerkend (SE/DE)

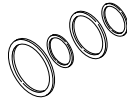
Referentie	Benaming	Afbeelding
326084	Bedieningshendel 4 functies 2 knoppen	
326085	Bedieningshendel 6 functies 4 knoppen	
316204	Hendel met 2 knoppen	
316203	Hendel met 4 knoppen	
300652	Aluminium as	
300655	Vast scharnier	
300648	Bedieningsconsole (bevat aluminium as en vast scharnier)	
300651	Balg	

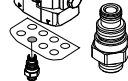
Referentie	Benaming	Afbeelding
		
300682	Verbindingsset kabel / schuif (2-deelsbehuizing – L: 54 mm)	
327453	Afdichtset	
329453	Verbinding voor externe drukaansluiting: voor aansluiting frontheft (M12)	
305802	Verbinding voor externe drukaansluiting: voor extra hydraulische functie (M15)	

Kabels

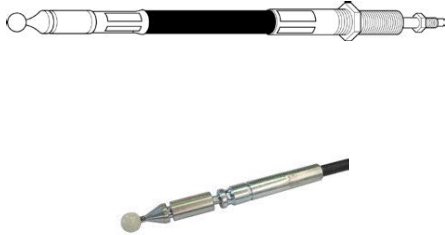







Referentie	Benaming	Afbeelding
319736	Totale lengte: 1.100 mm	
300680	Totale lengte: 1300 mm	
300679	Totale lengte: 1500 mm	
300668	Totale lengte: 1800 mm	
300669	Totale lengte: 2100 mm	
300675	Totale lengte: 2400 mm	
300676	Totale lengte: 2800 mm	
300677	Totale lengte: 3000 mm	
300670	Totale lengte: 3200 mm	
300678	Totale lengte: 3400 mm	
300671	Totale lengte: 3600 mm	
300672	Totale lengte: 3800 mm	
300673	Totale lengte: 4000 mm	
300674	Totale lengte: 4200 mm	



MX T406 - T408 - T410 - T412 - T417 - T418
 MX U303 - U304 - U305 - U306 - U307
 MX U308 - U309 - U310 - U312

vanaf 4/2013





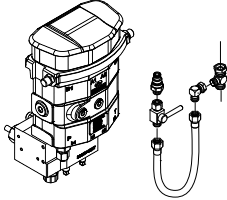
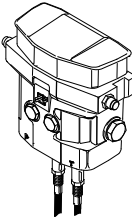

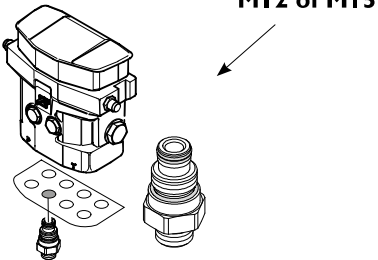
PROPILOT - Hydraulisch en 2 Dubbelwerkend + Zweefstand (2DE + PF)

Referentie	Benaming	Afbeelding
524829	Bedieningshendel 3 knoppen (geen gedetailleerde kaart)	
524830	Bedieningshendel 7 knoppen (geen gedetailleerde kaart)	
525147	Stuurknuppel met 3 knoppen (geen gedetailleerde kaart)	
525156	Stuurknuppel met 7 knoppen (geen gedetailleerde kaart)	
300652	Aluminium as	
300655	Vast scharnier	
300648	Bedieningsconsole (bevat aluminium as en vast scharnier)	
526075	Balg	
536404	Vervangkit kaart 2 knoppen	

Referentie	Benaming	Afbeelding
536405	Vervangkit buigzaam toetsenbord	
530671	Enkelwerkende kit op hydraulisch regelventiel – Manuele activering	
534798	Kit 2e SHOCK ACCUMULATOR SYSTEM * Om de ophanging met laag laadvermogen te optimaliseren	
300682	Verbindingsset kabel / schuif (2-deelsbehuizing – L: 54 mm)	
327453	Afdichtset	
329453	Verbinding voor externe drukaansluiting: voor aansluiting frontheft (M12)	 <p data-bbox="1278 1167 1422 1198">M12 of M15</p>
305802	Verbinding voor externe drukaansluiting: voor extra hydraulische functie (M15)	

Bedieningshendel voor Compact-frontladers

Referentie	Benaming	Afbeelding
524828	Bedieningshendel zonder knoppen vanaf april 2013 (geen gedetailleerde kaart)	
328967	Bedieningshendel met 2 functies zonder knop voor april 2013 (voor EV)	
328968	Hendel zonder knop voor april 2013	
525154	Hendel zonder knop vanaf april 2013	

Kabels











Referentie	Benaming	Afbeelding
319736	Totale lengte: 1.100 mm	
300680	Totale lengte: 1300 mm	
300679	Totale lengte: 1500 mm	
300668	Totale lengte: 1800 mm	
300669	Totale lengte: 2100 mm	
300675	Totale lengte: 2400 mm	
300676	Totale lengte: 2800 mm	
300677	Totale lengte: 3000 mm	
300670	Totale lengte: 3200 mm	
300678	Totale lengte: 3400 mm	
300671	Totale lengte: 3600 mm	
300672	Totale lengte: 3800 mm	
300673	Totale lengte: 4000 mm	
300674	Totale lengte: 4200 mm	

MX 60 - 80 - 100 - 120 - 150
 MX T6 - T8 - T10 - T12 - T15 - T16
 MX U6 - U8 - U10 - U12

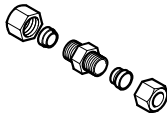

Van 2005 tot 3/2013

FLEXPILOT - Hydraulisch en Enkelwerkend / Dubbelwerkend (SE/DE)

Referentie	Benaming	Afbeelding
332888	Hendel met 2 knoppen (geen gedetailleerde elektronische kaart)	
332887	Hendel met 4 knoppen (geen gedetailleerde elektronische kaart)	
332829	Bovenste balg	
332918	Onderste balg	
500952	Klinkmoer + Olijf	
512604	Volledige afdichtset voor Flexipilot-verdeler (cilinderkop)	
534495	Reparatiekit flexibele leiding	
501312	Lagedrukaccumulator (0,16 L)	
332838	Geheel bedieningshendel Flexipilot CO (open centrum) 4 functies, 2 knoppen	
332839	Geheel bedieningshendel Flexipilot LS (Load Sensing) 4 functies, 2 knoppen	

Referentie	Benaming	Afbeelding
333816	Geheel van leidingen	
517302	Leiding	
524292	Cilinderkop lage druk Open centrum <i>(voor 4/2013)</i>	
524293	Cilinderkop lage druk Load Sensing <i>(voor 4/2013)</i>	
550873	Cilinderkop lage druk Open centrum <i>(na 4/2013)</i>	
548630	Cilinderkop lage druk Load Sensing <i>(na 4/2013)</i>	
526813	Afdichtset Flexpilot-bedieningshendel voor 4/2013 (stalen voetstuk)	

MX T406 - T408 - T410 - T412 - T417 - T418



MX U303 - U304 - U305 - U306 - U307
MX U308 - U309 - U310 - U312

vanaf 4/2013



Flexpilot – Hydraulisch en twee Dubbelwerkend + Zweefstand (2DE + PF)

Referentie	Benaming	Afbeelding
525156	Stuurknuppel met 7 knoppen	
529480	Bovenste balg	
526074	Onderste balg	
500952	Klinkmoer + Olijf	
512604	Volledige afdichtset Flexpilot-verdeler (cilinderkop)	
534495	Reparatiekit flexibele leiding	
501312	Lagedrukaccumulator (0,16 L)	
333816	Geheel van leidingen	



Referentie	Benaming	Afbeelding
517302	Leiding	
536404	Vervangkit kaart 2 knoppen	
536405	Vervangkit buigzaam toetsenbord	
529606	Volledige bedieningshendel	
536406	Vervangkit buigzaam toetsenbord Tech3	

6. WERKTUIGEN

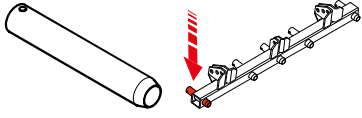
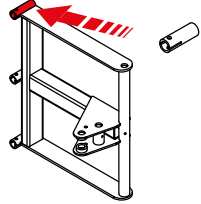
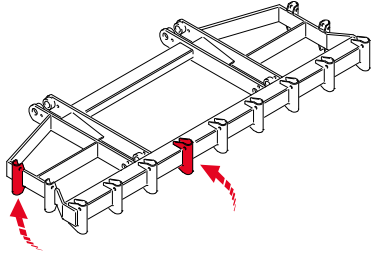
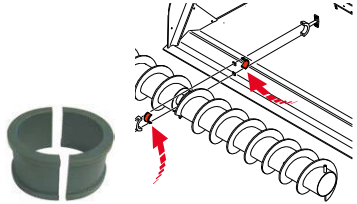
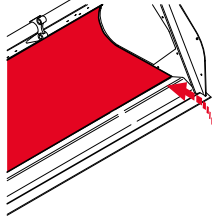
Sokkels voor mestbak, steunen om te lassen

	Referentie	Benaming	Afbeelding
MESTVORK	313181	Sokkel voor mestbak 10 lagerbussen – L: 2 m (te zagen naargelang het model van de bak) voor 2017	
	316260	Sokkel voor BF 225 voor 2017	
	313464	Lagerbus moet gelast worden voor sokkel voor mestbak Ø 35 mm – L: 168 mm	
MANUBAL	313434	Lagerbus moet gelast worden voor Manubal Ø 40 mm – L: 350 mm	
	313474	Lagerbus om te solderen voor Manubal (oude serie) Ø 25,5 mm – L: 100 mm	
	513301	Lagerbus om te solderen voor Manubal V	
GRIJPER	313579	Ondersteuning voortanden grijper Ø 25 mm	
	313580	Ondersteuning zijtanden grijper Ø 25 mm	
	312717	Ondersteuning voortanden grijper Ø 28 mm	
	312718	Ondersteuning zijtanden grijper Ø 28 mm	
LAADBAK	310584	Slijtring voor lager van verdeelbak Ø 90 mm – L: 110 mm	
	522621	Plaatjzer voor bodem van verdeelbak	

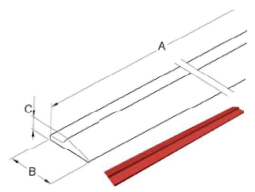
Slijtranden

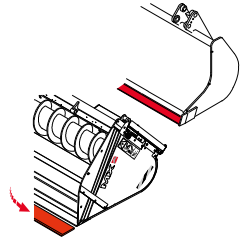
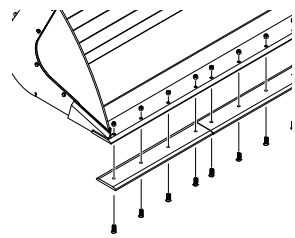
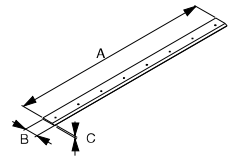
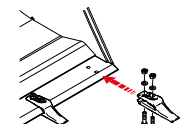
Referentie	Benaming	Kenmerken	Afbeelding
310741	<p>Slijtplaten I schuine rand om te lassen</p>  <p>voor BMS / BMSA BR / BT (te zagen naargelang het model van de bak)</p>	<p>A: 2.514 mm B: 150 mm C: 32 mm Hardheid: 250</p>	
505820	<p>Slijtvaste tegenmessen vlak om te lassen</p>  <p>BMS / BMSA BR / BT (te zagen naargelang het model van de bak) voor 2015</p>	<p>A: 2.514 mm B: 150 mm C: 15 mm Hardheid: 400</p>	
549 665		Breedte: 2100 mm	
536039		Breedte: 2300 mm	
536040	Kits slijtvaste tegenmessen omkeerbaar om te klinken	Breedte: 2.450 mm	
538905	voor BMSA / BCA Hardheid: 400 HB	Breedte: 2.650 mm	
539075	vanaf 2015	Breedte: 2800 mm	
549666		Breedte: 3000 mm	
528125 A: 1.312 mm 528120 A: 1.512 mm 528115 A: 1820 mm 528055 A: 2.021 mm 528068 A: 2270 mm 534796 304604	<p>Slijtvaste tegenmessen vlak om te klinken</p> <p>– BT130 – BT150 – BT180 – BT200 – BT225 –Schroef FHC M12 x 50 – Moer rem HFR M12</p>	<p>B: 150 mm C: 32 mm Hardheid: 400</p>	
534775 304097 304604	<p>Tand voor BT om te klinken Bevestigingsschroef – Schroef H M12 x 50 Moer rem HFR M12 vanaf 2015</p>		

Bovenklempennen (BMS / BMSA)

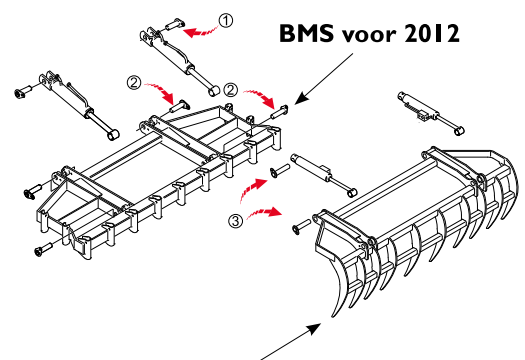
Referentie	Benaming	Afbeelding
307316	Pen 1: Ø 30 x L 85 mm	 <p>BMS voor 2012</p> <p>BMSA voor 2015</p>
307319	Pen 2: Ø 30 x L 135 mm	
503195	Pen 3: Ø 30 x L 170 mm (telescopisch)	

Referentie	Benaming	Afbeelding
517647	Pen 1: Ø 30 x L 89 mm	
523150	Pen 2: Ø 30 x L 135 mm	

Tanden

Referentie	Kenmerken	Modellen	Afbeelding
300537	Ø 25 L: 440 mm (BMS / GF voor 1997)		 <p>Opzij</p> <p>Frontaal</p>
300536	Ø 25 L: 560 mm (BMS / GF voor 1997)		
300535*	Ø 25 L: 560 mm (BMS / GF voor 1997)		
521828	Ø 25 L: 400 mm (BMSC 118)		
504664	Ø 25 L: 436 mm (BMS 130 – 150)		
300540	Ø 28 L: 440 mm (BMS tot 2012)		
300539	Ø 28 L: 560 mm (BMS tot 2012)		
523098	Ø 29,5 L: 560 mm (BMS vanaf 2012)		
300526	Ø 35 L: 860 mm (BF / BFU / CG / CGU)		
300530	Ø 35 L: 1.200 mm (BR 15 / L 40)		
300528	Ø 30 L: 760 mm BR 20		
300531	Ø 30 L: 1.200 mm		
300529	Ø 35 L: 760 mm		
521691	Ø 40 L: 1.000 mm (MNB V6000 / V7000 – L6000 / L500)		
300532	Ø 40 L: 1.200 mm (L500 / L6000 – V6000 / V7000)		
300533	Ø 40 L: 1.400 mm		
300541	Ø 30 L: 660 mm BD / BMSA / CGA		
542816	Ø 35 L: 670 mm BMSA MO / HO / HDO na 2015		
300538	Ø 25 L: 560 mm		
524810	Ø 40 L: 1.400 mm (MNB L500)		
300542	Ø 45 L: 1.000 mm (BFA 230 – 250)		
514733	Ø 25 L: 440 mm C = 386 mm D = 125 mm Manubal V40...V6000, W500		
300546	Ø 25 L: 550 mm C: 480, D: 230 Manubal 130...660		
300547	Ø 25 L: 550 mm C: 370, D: 320 Vaste bovenklem van laadbak		
311407	Ø 25 L: 650 mm Compacte mestvork		

Referentie	Kenmerken	Modellen	Afbeelding
519647	Ø 25 L: 500 mm Mestbak		

* Hoek van de tand

Afdichtset voor cilinders - werktuigen

Referentie	Benaming	Ø Stang x Ø Zuiger x Ø Opening	Afbeelding
Afdichtset cilinder			
305307	304996	Cilinder Ø 35 x 63 / 200 met beugel enkel op BMS voor 2012	35 x 63 x 71
525393	523038	Cilinder Ø 35 x 63 / 200 met beugel enkel BMS na 2012	35 x 63 x 71
305311	vervangen door 304996	Cilinder Ø 35 x 70 / 200 met beugel	35 x 70 x 80
305289	304942	Cilinder Ø 30 x 60 / 200	30 x 60 x 70
305301	304954	Cilinder Ø 35 x 60 / 250	35 x 60 x 70
305306	304990	Cilinder Ø 35 x 63 / 300	35 x 63 x 73

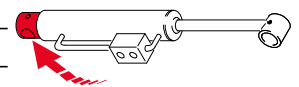

7. ELEKTRISCH

Tot 3/2013

3-4 functies

5-6 functies

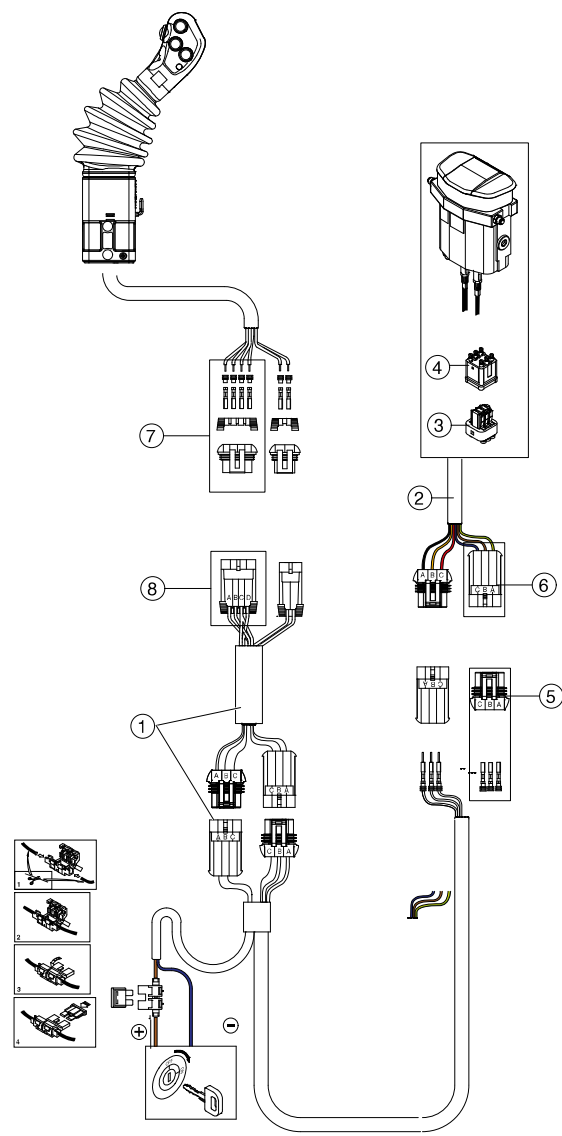
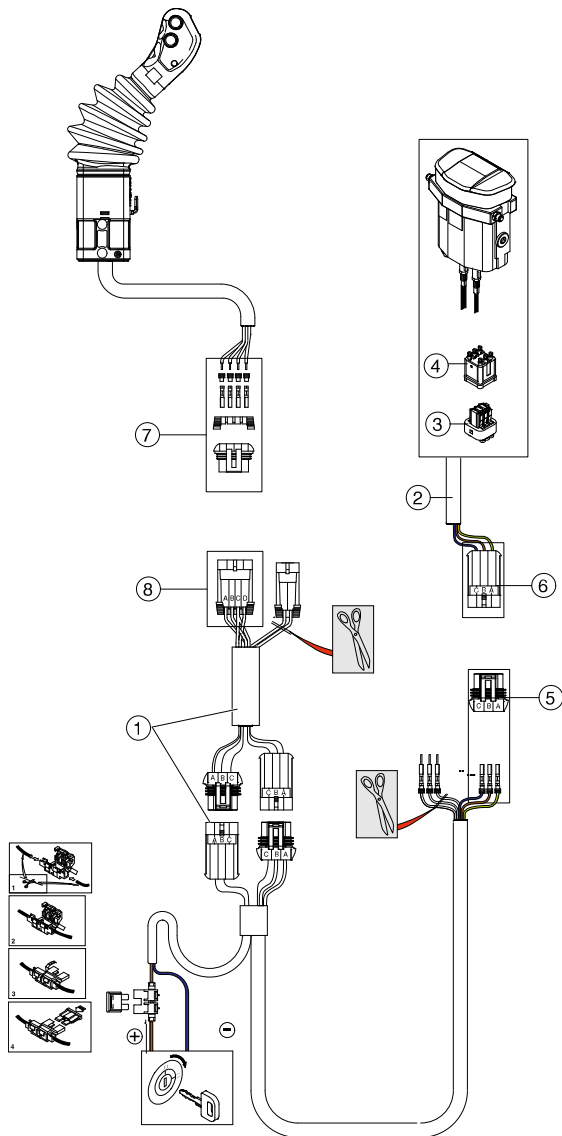

1. Kabelboom tractor	306273	1. Kabelboom tractor	306273
2. Kabelboom verdeler	306274	2. Kabelboom verdeler	306275
3. Aansluiting (mannelijk)	306316	3. Aansluiting (mannelijk)	306316
4. Aansluiting (vrouwelijk)	306331	4. Aansluiting (vrouwelijk)	306331
5. 3-wegsaansluiting (mannelijk)	306320	5. 3-wegsaansluiting (mannelijk)	306320
6. 3-wegsaansluiting (vrouwelijk)	306319	6. 3-wegsaansluiting (vrouwelijk)	306319
7. 4-wegsaansluiting (mannelijk)	306322	7. 4-wegsaansluiting (mannelijk)	306322
8. 4-wegsaansluiting (vrouwelijk)	306321	8. 4-wegsaansluiting (vrouwelijk)	306321

vanaf 4/2013





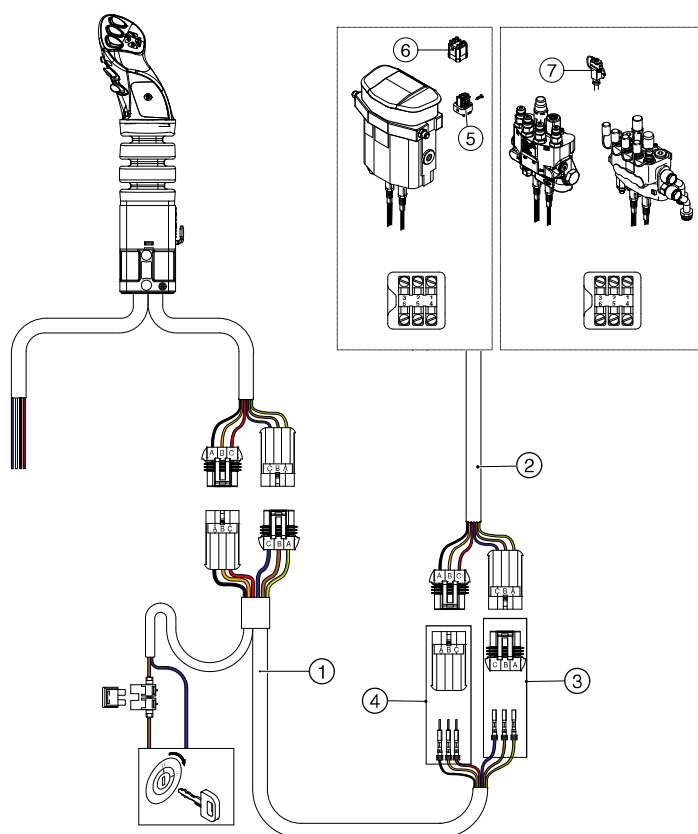
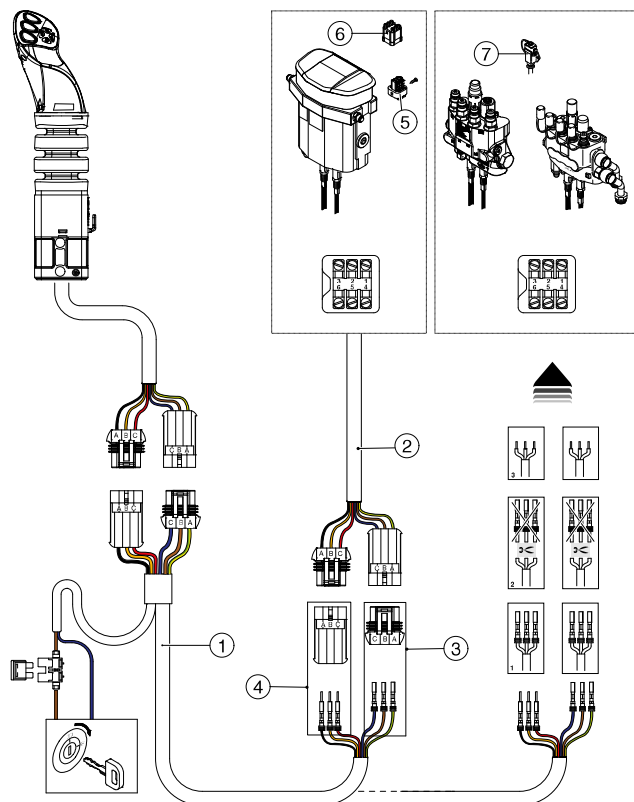





4 functies

6 functies







1. Kabelboom tractor	525488	1. Kabelboom tractor	525488
2. Kabelboom verdeler	306275	2. Kabelboom verdeler	306275
3. 3-wegsaansluiting (mannelijk)	306320	3. 3-wegsaansluiting (mannelijk)	306320
4. 3-wegsaansluiting (vrouwelijk)	306319	4. 3-wegsaansluiting (vrouwelijk)	306319
5. Elektrische aansluiting (mannelijk)	306316	5. Elektrische aansluiting (mannelijk)	306316
6. Elektrische aansluiting (vrouwelijk)	306331	6. Elektrische aansluiting (vrouwelijk)	306331
7. Elektrische aansluiting (mannelijk)	306342	7. Elektrische aansluiting (mannelijk)	306342

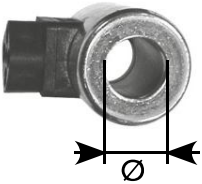

Elektromagnetisch ventiel voor de 3e functie

Referentie	Kenmerken	Afbeelding
305726	MX 200 / 400	
305789 of 305775 + 334043	MX 4070 / 4070M* MX 4085 / 4085M* MX 6000 / 6000M*	    Drukbegrenzer Elektromagnetisch blok enkel
305789 of 305775 + 334043	MX 60 tot 155	    Drukbegrenzer Elektromagnetisch blok enkel
503215	MX T06 / T400	







* Bij elektromagnetisch ventiel met drukbegrenzer monobloc

Solenoides



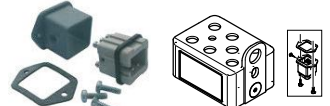
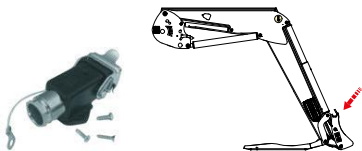



Referentie	Kenmerken	Afbeelding
		
306371	Ø 19 mm	
306372 vervangen door 326629	Ø 22 mm	
326629	Ø 23 mm	

Referentie	Kenmerken	Afbeelding
506768	Ø 25,6 mm	
306373	Ø 31 mm	









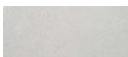

Aansluitingen - Elektromagnetisch ventiel - Schakelaars

Referentie	Benaming	Afbeelding
306316	Aansluiting (mannelijk)	
306331	Aansluiting (vrouwelijk)	
312793	Aansluiting (mannelijk) Mach 90/92	
312794	Aansluiting (vrouwelijk) Mach 90/92	
306342	Koppeling werktuig (mannelijk)	
306341	Koppeling werktuig (vrouwelijk)	
306238	Koppeling elektromagnetisch ventiel	
306241	Complete schakelaar – elektrokit 3 functies (drukknop)	

Koppeling achteraan

Referentie	Benaming	Afbeelding
306767	Ringbout om te lassen	Ø 46 mm 
310964	Vergrendelingskit met standaard ringbout	
309815	Ontgrendeling koppeling: Kabel + handvat	
307166	Ontgrendeling koppeling: Verstelbare kabel	
307168	Ontgrendeling koppeling: Kabel L: 1620 mm	
307169	Ontgrendeling koppeling: Kabel L: 2270 mm	

10. VERF

Referentie	Benaming	Pot I I	Spray 400 ml
530333	Titaniumgrijs getextureerd Serie T400, serie U400, serie U300, serie F300, serie A100, Compact		-
528684	Titaniumgrijs getextureerd Serie T400, serie U400, serie U300, serie F300, serie A100, Compact	-	
537464	Titaniumgrijs glad MULTIMASS	-	
522411	Zilvergrijs Serie T06 (T10 - T12)		-
508727	Zilvergrijs Serie T06 (T10 - T12)	-	
518356	Kwartsgrijs Series Compact +, Utility 09, Technic 97 (MX100 ...)		-
308232	Kwartsgrijs Series Compact +, Utility 09, Technic 97 (MX100 ...)	-	
518357	Antracietgrijs glad Werktuigen, frontheefs, aanpassingen, cilinders, drijfstangen, werktuigdragers (Serie Technic Serie T)		-
308233	Antracietgrijs glad Werktuigen, frontheefs, aanpassingen, cilinders, drijfstangen, werktuigdragers (Serie Technic Serie T) voor 9/2018	-	
551278	Antracietgrijs getextureerd Werktuigen, frontheefs, aanpassingen, cilinders, drijfstangen, werktuigdragers (Serie Technic Serie T) na 9/2018	-	
518358	Serie ROOD (40-85 ...)		-

